



rugged. interactive

# CardioWall® Landscape

**Order and Installation Manual**  
For models from October 2023 onwards



**Rugged Interactive**

Unit 1, Callywith Court  
Callywith Industrial Estate, Bodmin  
Cornwall, UK  
PL231 2RQ

+44 (0) 1726 981 123  
[www.rugged-interactive.com](http://www.rugged-interactive.com)  
[hello@rugged-interactive.com](mailto:hello@rugged-interactive.com)



**Rugged Interactive**  
Unit 1, Callywith Court  
Callywith Industrial Estate, Bodmin  
Cornwall, UK  
PL31 2RQ

+44 (0) 1726 981 123  
www.rugged-interactive.com  
hello@rugged-interactive.com

# Contents

---

## **Section 1 – Ordering Process**

- 1.1 Need to Know
- 1.2 Order and Installation Checklist
- 1.3 Product Overview
- 1.4 Ordering and Installation Timeline
- 1.5 Getting Started
- 1.6 Place Order

## **Section 2 – Safety Guidelines**

- 2.1 Installation Safety Guidelines
- 2.2 In Play Safety Guidelines

## **Section 3 – Installation**

- 3.1 Parts List
- 3.2 Tools and Components List
- 3.3 Installation Overview
- 3.4 Detailed Installation

## **Section 4 – How to Use**

## **Section 5 – Programs Guide**

**CardioWall Landscape System Specifications**

**CardioWall Landscape Installation Checklist**

**Next Steps**



## Rugged Interactive

Unit 1, Callywith Court  
Callywith Industrial Estate, Bodmin  
Cornwall, UK  
PL31 2RQ

+44 (0) 1726 981 123

[www.rugged-interactive.com](http://www.rugged-interactive.com)

[hello@rugged-interactive.com](mailto:hello@rugged-interactive.com)

# Section 1 – Ordering Process

---

## 1.1 - Need to Know

### Installation manual purpose and limitations

This manual is intended to provide guidance only, the installation of the Rugged Interactive product will be under your control. You will be responsible for making sure, upon completion of the installation, it is safe to use. As always, we are here to support you, please get in touch if you are in any doubt.

### Regulations

Some countries and states have regulations which may be applicable to the Rugged Interactive products, it is your responsibility to check that the product complies with such regulations. This should be conducted during the planning phase for the installation location.



## Rugged Interactive

Unit 1, Callywith Gate  
Callywith Industrial Estate, Bodmin  
Cornwall, UK  
PL31 2RQ

+44 (0) 1726 981 123

[www.rugged-interactive.com](http://www.rugged-interactive.com)

[hello@rugged-interactive.com](mailto:hello@rugged-interactive.com)

## 1.2 - Order and Installation Checklist

---

- Contact the Rugged Interactive sales team or a partner / distributor to begin the process.
- Confirm the invoice and delivery address along with date required (lead time is at least 5 weeks), VAT number required for export customers.
- Complete site survey.
- Send purchase order or confirm order.
- Make first payment.
- Discuss graphic requirements and provide logos and branding guidelines.
- Approve graphics.
- Make second payment (required a week before dispatch).
- Schedule time and team members for installation.
- Before install, confirm all tools and components are prepared.
- Organise shipment (Customer collection or delivery organised by Rugged Interactive).
- Receive your order.
- Install the product.
- Test and complete installation checklist.
- Train the team on how to use the product.
- Sounds can be heard when the targets are hit.
- Reveal your new Rugged Interactive product to your guests and customers!



**Rugged Interactive**  
 Unit 1, Callywith Gate  
 Callywith Industrial Estate, Bodmin  
 Cornwall, UK  
 PL31 2RQ

+44 (0) 1726 981 123  
 www.rugged-interactive.com  
 hello@rugged-interactive.com

## 1.3 – CardioWall® Landscape Overview

A captivating interactive challenge that allows users to get a lot of exercise without even realising it! The CardioWall can stimulate a huge range of functional exercises and motor skills.

The CardioWall Landscape features multiple game modes. A 'blank canvas' for PT's to create their own routines for clients. Every routine is a game, challenging users to beat their previous best score, their friends or the leader board.

Featuring a large, fully customisable graphic panel, the CardioWall Landscape will be sure to capture the attention of players with its visually striking appearance.



## 1.4 - Order and Installation Timeline

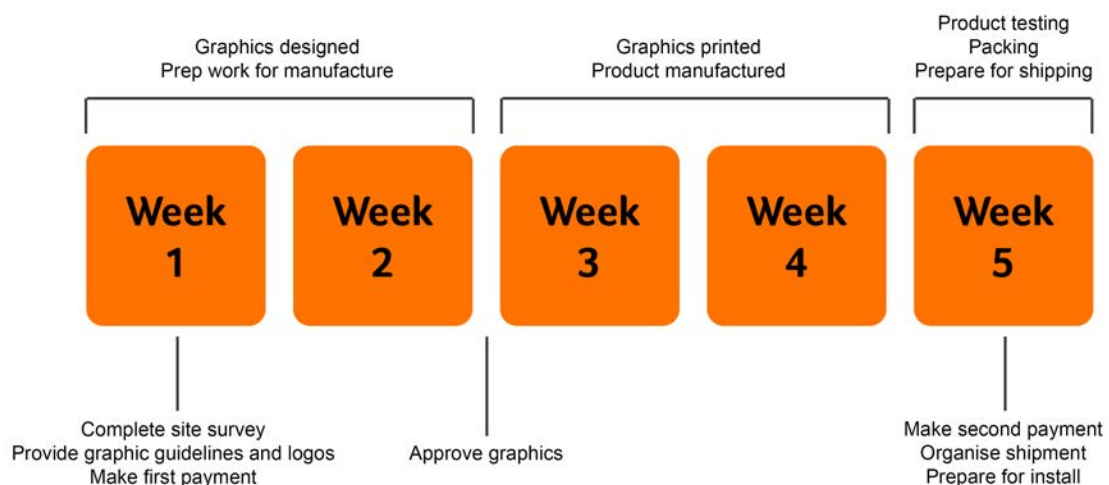

\*We do our best to ensure orders are ready on a five-week lead time, however during busy periods or for large orders, the lead time may be longer than outlined here. Lead time will also be affected by graphics guidelines, approval and payment delays.



## Rugged Interactive

Unit 1, Callywith Court  
Callywith Industrial Estate, Bodmin  
Cornwall, UK  
PL31 2RQ

+44 (0) 1726 981 123

[www.rugged-interactive.com](http://www.rugged-interactive.com)

[hello@rugged-interactive.com](mailto:hello@rugged-interactive.com)

## 1.5 - Getting Started

---

### New Parks

During the design process for the new park, incorporate the intended products into the design, product specifications can be found within this manual for the relevant product and CAD files can be supplied upon request.

### Existing Parks

When retrofitting existing parks, all specifications can be found within this manual or CAD files are available at request. If further information is required, please get in touch and we will be able to provide further information and guidance.

## 1.6 - Place Order

---

To begin the order process with Rugged Interactive:

Email:

[Sales@rugged-interactive.co.uk](mailto:Sales@rugged-interactive.co.uk)

Or call the Sales Office:

+44 (0) 7585 955 184

#### HQ/Production Address:

Unit 1 Callywith Court  
Callywith Ind. Estate,  
Bodmin,  
Cornwall  
UK  
PL31 2RQ

#### Sales Office Address:

Rugged Interactive,  
Future Space,  
UWE North Gate,  
Filton Road,  
Bristol,  
UK  
BS34 8RB



**Rugged Interactive**  
Unit 1, Callywith Court  
Callywith Industrial Estate, Bodmin  
Cornwall, UK  
PL31 2RQ

+44 (0) 1726 981 123  
www.rugged-interactive.com  
hello@rugged-interactive.com

## Section 2 - Safety Guidelines

---

### 2.1 Installation Safety Guidelines

Before installing any Rugged Interactive product, please read the following:

#### Dos:

- Ensure that a Site Survey form has been completed prior to installation.
- Have ready suitable equipment, tools and/or man power.
- Observe correct manual handling techniques whilst moving and installing the equipment.
- If being installed onto a wall, the product **MUST** be mounted onto a wall of a construction capable of supporting its weight and gameplay. If possible, avoid stud walls or unsupported portal infills. If in doubt always contact a suitably qualified surveyor to check.
- Visually check the product for any signs of damage, component failure and/or missing parts.
- To prevent electric shock, keep all electric components away from contact with water.
- Ensure to take anti-static precautions.
- Wear appropriate clothing: do not wear loose clothing or jewellery.
- Long hair should be tied back.
- Tidy back loose cables that could become a tripping hazard.
- Ensure that the playing area is clear.
- Immediately inform Rugged Interactive for maintenance advice if you have concerns.

#### Don'ts:

- Do not wear shoes with leather soles or high heels.
- Do not use any tools that are not specifically recommended by the manufacturer.
- Do not use the surface of the trampoline to balance ladders or alike.
- Do not distract others while they are installing the product.

## **2.2 In Play Safety Guidelines**

Please ensure you read the following points before using the equipment:

### **Dos:**

- Ensure that a Site Survey form has been completed prior to installation.
- Have ready suitable equipment, tools and/or man power.
- Observe correct manual handling techniques whilst moving and installing the equipment.
- If being installed onto a wall, the product **MUST** be mounted onto a wall of a construction capable of supporting its weight and gameplay. If possible, avoid stud walls or unsupported portal infills. If in doubt always contact a suitably qualified surveyor to check.
- Visually check the product for any signs of damage, component failure and/or missing parts.
- To prevent electric shock, keep all electric components away from contact with water.
- Ensure to take anti-static precautions.
- Wear appropriate clothing: do not wear loose clothing or jewellery.
- Long hair should be tied back.
- Tidy back loose cables that could become a tripping hazard.
- Ensure that the playing area is clear.
- Immediately inform Rugged Interactive for maintenance advice if you have concerns.

### **Don'ts:**

- Do not wear shoes with leather soles or high heels.
- Do not use any tools that are not specifically recommended by the manufacturer.
- Do not distract others while they are installing the product.



## **1.2 In Play Safety Guidelines**

Please ensure you read the following points before using the equipment:

### **Dos:**

- Before beginning any exercise program, it is recommended that you consult with your doctor.
- Children under the age of 7 years must always be supervised by an adult (over 16 years) when using the equipment and/or recommended accessories.
- Visually check the equipment before using it for any signs of damage, component failure or loose cables that could become a tripping hazard. Report any concerns, e.g. loose holds or damaged equipment, to a member of staff immediately.
- Ensure you familiarise yourself with any additional facility rules that may apply.
- Ensure that the play area in front of the equipment is clear before attempting to participate.
- Only participate if you are in good physical condition. Participate only within your capabilities / recommended exercise level.
- Wear appropriate clothing.
- Remove all items from your pockets prior to participation.
- Long hair should be tied back.
- Before use, loosen up with warm up exercises and stretches.
- Only those participating are allowed in the activity area. If waiting to participate, stand back at a safe distance from the equipment.
- Report any unusual or inappropriate behaviour to a member of staff immediately.
- If you get tired, leave the equipment / activity area and take a break.
- If you feel any pain, dizziness, nausea or any other abnormal symptoms, **STOP YOUR WORKOUT IMMEDIATELY**. Consult your doctor immediately. Incorrect or excessive training may lead to injuries.

### **Don'ts:**

- Do not attempt to use any of the equipment without undertaking instruction / training carried out by an appropriate instructor.
- Do not participate if you are unwell or have any pre-existing medical conditions including heart, back, neck, bone and/or muscle conditions.
- Do NOT work to exhaustion.
- Do not participate if you are or maybe pregnant.
- Do not wear loose clothing or jewellery (including studs and watches). Clothing should not have any hard or sharp points (such as buckles, studs, toggles or alike).
- Do not wear shoes with leather soles, high heels, sandals, boots or bare feet.
- No food, drink or chewing gum during participation.

## CardioWall® Landscape Order and Installation Manual: *Safety Guidelines*

- No phones or cameras in the activity area.
- Do not leave clothing or personal belongings around the activity areas.
- Do not participate under the influence of alcohol and/or drugs.
- Do not distract others while they are using the equipment.
- Do not sit, lie, stand or rest on or under the activity equipment.
- Do not use any accessories that are not specifically recommended by the manufacturer. These might cause injuries or cause the equipment to fail.

**NOTE:** This activity can be great fun, but it can also be dangerous. There is a risk of serious injury if care is not taken when using the equipment. Use of this equipment is physically demanding: this is a high-impact, full body activity which requires intense focus, awareness of your body's strengths and limitations, awareness of the environment around you and extreme caution.



## Rugged Interactive

Unit 1, Callywith Gate  
Callywith Industrial Estate, Bodmin  
Cornwall, UK  
PL31 2RQ

+44 (0) 1726 981 123

[www.rugged-interactive.com](http://www.rugged-interactive.com)

[hello@rugged-interactive.com](mailto:hello@rugged-interactive.com)

## Section 3 - Installation

---

### 3.1 - Parts List

Please check off the received parts for the installation and alert Rugged Interactive immediately if anything is missing.

1 x Landscape Wall (two halves).	<input type="checkbox"/>
1 x Spare Pod.	<input type="checkbox"/>
10 x Wall plugs.	<input type="checkbox"/>
10 x M8 x 50 coach screws.	<input type="checkbox"/>
10 x M8 x 25 washers.	<input type="checkbox"/>
Poster.	<input type="checkbox"/>
Manual.	<input type="checkbox"/>

### 3.2 - Tools and Components List

---

Arrange the necessary tools and the team to install the product.

Ladder.	<input type="checkbox"/>
Spirit level.	<input type="checkbox"/>
Cordless drill – with torque adjuster to avoid over-tightening the screws.	<input type="checkbox"/>
Industrial vacuum cleaner.	<input type="checkbox"/>
Dustpan and brush.	<input type="checkbox"/>
SDS impact drill.	<input type="checkbox"/>
Socket set.	<input type="checkbox"/>
A set of No.2 Pozi bits.	<input type="checkbox"/>
A set of screwdrivers.	<input type="checkbox"/>
A set of Hex keys	<input type="checkbox"/>



## Rugged Interactive

Unit 1, Callywith Court  
Callywith Industrial Estate, Bodmin  
Cornwall, UK  
PL31 2RQ

+44 (0) 1726 981 123

[www.rugged-interactive.com](http://www.rugged-interactive.com)

[hello@rugged-interactive.com](mailto:hello@rugged-interactive.com)

### 3.3 - Installation Overview

---

Below is an overview of the steps needed to install CardioWall Landscape. More detail for the process is provided in the following pages. Please read through ALL of this prior to beginning the installation and if you are in any doubt, contact Rugged Interactive.

If you have any concerns on how or what the product is installed to, contact a structural engineer prior to beginning the installation.

**STEP 1:** Mark out mounting points.

**STEP 2:** Drill necessary holes.

**STEP 3:** Mount CardioWall Landscape.

**STEP 4:** Attach cables.

**STEP 5:** Replace graphics panel and pods.

**STEP 6:** Turn on CardioWall Landscape.

**STEP 7:** Test.

**STEP 8:** Check all is secured.

**STEP 9:** Stress relief cables.

**STEP 10:** Enjoy your CardioWall Landscape!



rugged. interactive

**Rugged Interactive**

Unit 1, Callywith Court  
Callywith Industrial Estate, Bodmin  
Cornwall, UK  
PL31 2RQ

+44 (0) 1726 981 123

[www.rugged-interactive.com](http://www.rugged-interactive.com)

[hello@rugged-interactive.com](mailto:hello@rugged-interactive.com)

## 3.4 – Detailed Installation

---

Read this manual **before** installing the CardioWall.

### Installation Guidelines:

- Please complete the **Site Survey** form prior to delivery and/or installation.
- Please send a completed **Installation Checklist** after any installation to Rugged Interactive.
- A typical installation should take 2 people about 2 hours.
- No obstructions or protrusions in the installation area: e.g. skirting boards, pipes, cables and wiring conduits.
- Avoid trapped and/or pinched cables.
- Use good practice when running data cables to and from products, external pods and sensors. Support long cables at least every 50 cm and provide adequate strain relief for connection points.
- Power supply to be within 100 cm of each CardioWall. Standard power cables are positioned bottom right.
- To prevent electric shock, keep all electric components away from contact with water.
- **IMPORTANT:** Take anti-static precautions.

### Structure:

- The units must be mounted to a flat/level construction capable of supporting its weight and gameplay. (Uneven walls and surfaces make alignment and fitting very difficult.)
- The wall area for installation will need to exceed the width and height of the CardioWall (refer to System Specifications) plus an additional 10 cm of clear space around each edge. If two CardioWalls are being positioned side-by-side, leave a gap of 150 cm - 300 cm.
- Typical suitable construction would be block built, portal frame with structural infills or brick built.
- Alternatively, mount onto 18 mm plywood (12 mm minimum) mechanically mounted to a steel framework (50 mm box minimum). Preferably, the plywood should be painted prior to installation.
- Adequate holes will need to be cut during installation to provide clearance for cable access to rear if required.
- Do not fix to plasterboard faced partition. Avoid stud walls or unsupported portal infills.

### Fixings:

- The manufacturer will supply fixings.
- Use hex-headed screws of 50-70 mm length (2") x M10 for a plywood structure.
- Use Rawl Plugs (plastic wall plugs) if mounted to a solid block or brick wall.
- 10 x 35 'penny' washers to spread the load at each bolt head are recommended.
- All fixings must be tight and secure.

**Required Tools and Consumables:**

- A spirit level – to check floor is level before installation and that the CardioWall is level during installation.
- An industrial vacuum cleaner.
- A dustpan and brush.
- A SDS impact drill.
- A cordless drill – with torque adjuster to avoid over-tightening of screws.
- A set of No.2 pozi bits.
- A set of screwdrivers:
  - A small electrical-type flat-bladed screwdriver to unclip the CAT5 connectors from the pods.
  - A tiny flat-bladed screwdriver to adjust the volume on the main hub.
- A socket set.

**Suggested Extras:**

- 3 m of self-adhesive 'mini' box trunking to secure the power cable.
- An extension cable in case the power supply is not within 1000 mm of the base of the CardioWall. (CardioWalls are supplied, unless otherwise requested, with a power adaptor cable that extends 1000 mm from the base of the CardioWall.)
- Cleaning cloth and gentle cleaning spray.

**Installation Heights:**

- Raised to a desirable level, consider the primary user group, along with their requirements.

**Operating Environment:**

- Keep out of direct sunlight; bright sunlight can affect the LED pod sensors.
- Keep indoors and dry.
- Optimum ambient temperature: 5°C to 30°C. Avoid extreme fluctuations of temperature.
- Area clear in front of the CardioWall: 200 cm minimum.

**Other Recommendations:**

- Instruction / training carried out by an appropriate instructor to all new users.
- A waiting / spectating area positioned nearby is advised.
- A leaderboard to go with each unit is highly recommended.

**IF YOU ARE IN ANY DOUBT, CALL RUGGED INTERACTIVE DIRECTLY ON +44 (0) 1726 833 882**

## CardioWall Landscape Installation

01

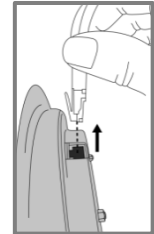
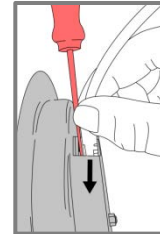
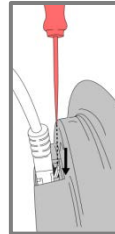
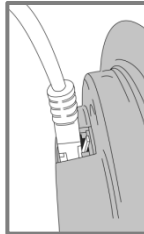
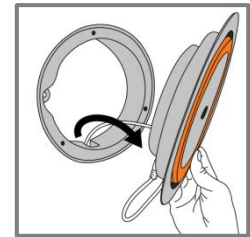
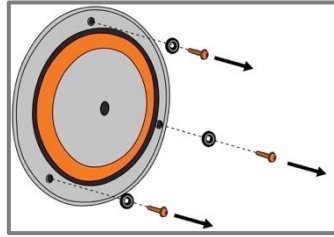
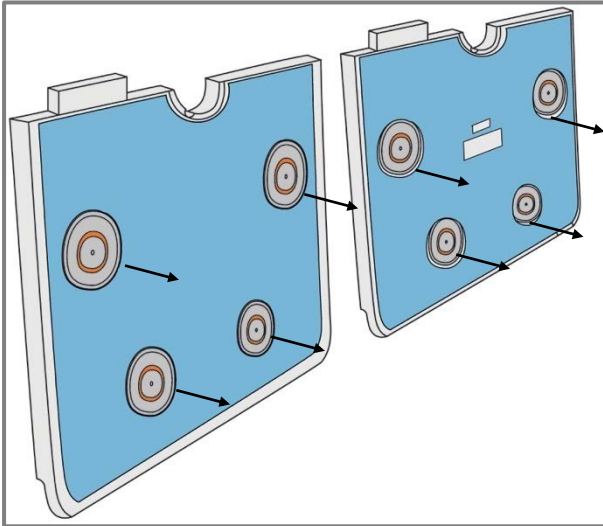

Remove pods x 8. Retain screws, washers and pods.

02

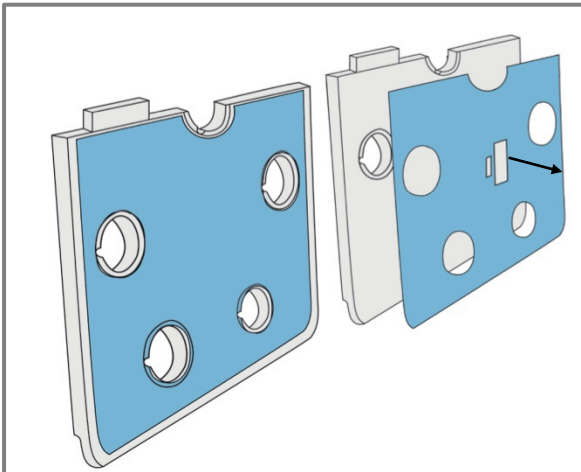

Remove the graphics panels from the moulding that contains the hub (i.e. the scoring screen).

Remove all the outside screws and washers. Retain screws and washers and store graphics panel in a safe place.

**NOTE: Before touching the hub, touch a grounded object to remove any static charge.**

The graphics panel on the other moulding can remain in place.

03

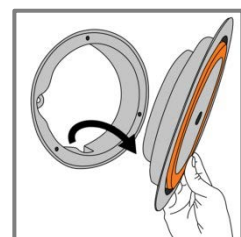
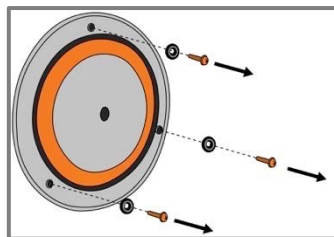
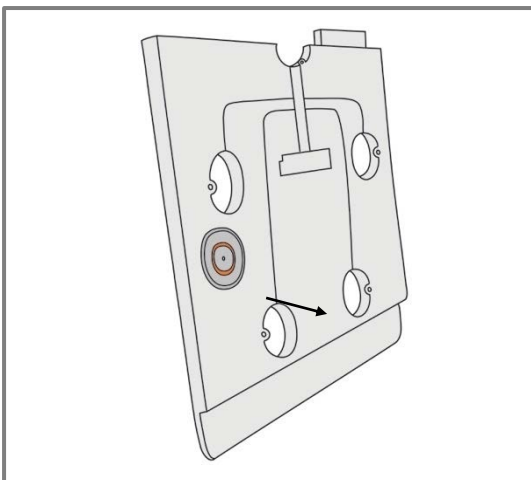

Remove pod x 1 from the back of the main body. Retain screws, washers and pod.



04

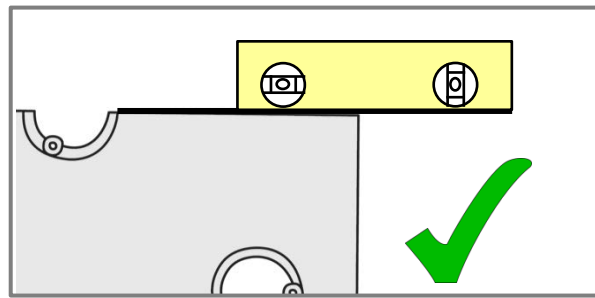
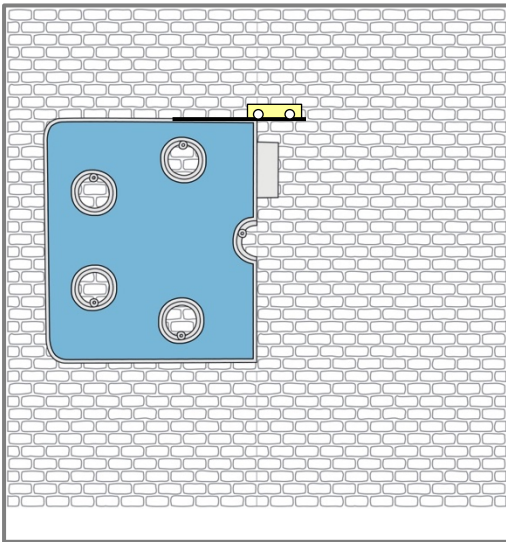

**2 people required:** one to hold the main body in place; one to ensure it is level.

Choose the CardioWall's height from the floor depending on primary user group. We recommend: 300 – 780 mm.

05

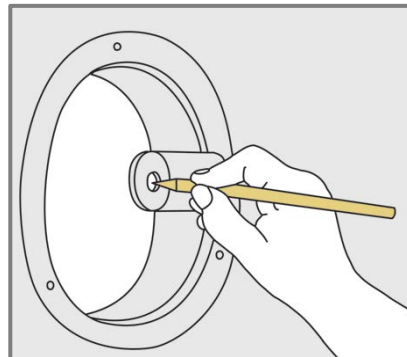
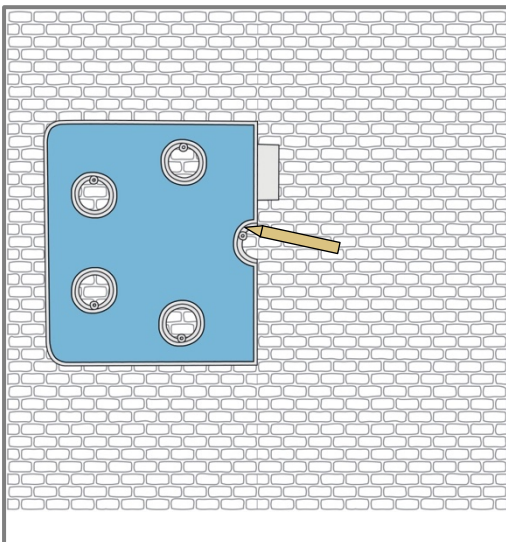

**2 people required:** one to hold the main body in place; one to clearly mark holes x 5.

06

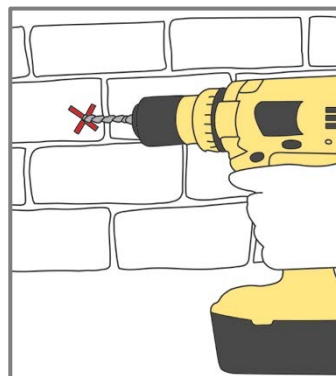
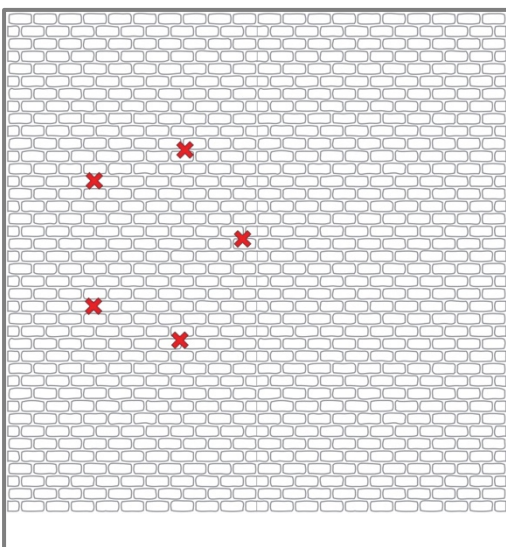

Drill holes and insert mountings x 5.



07

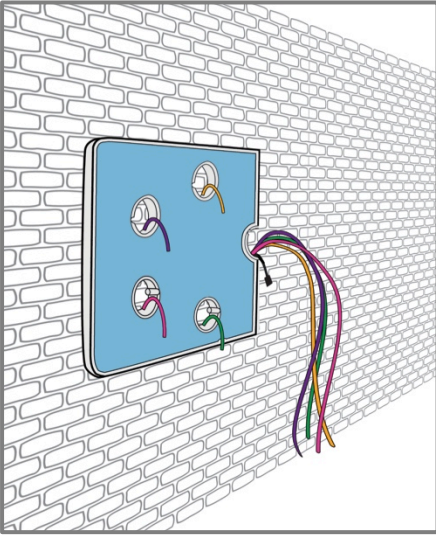

Ensure CAT5 cables are not trapped or pinched anywhere behind the left-side moulding of the CardioWall.

08

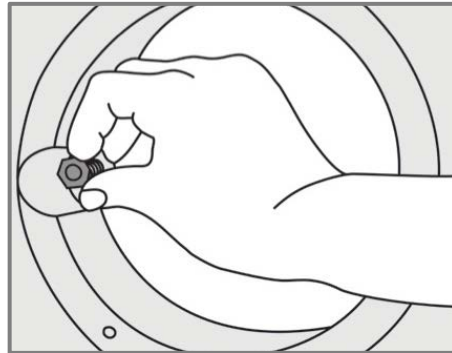
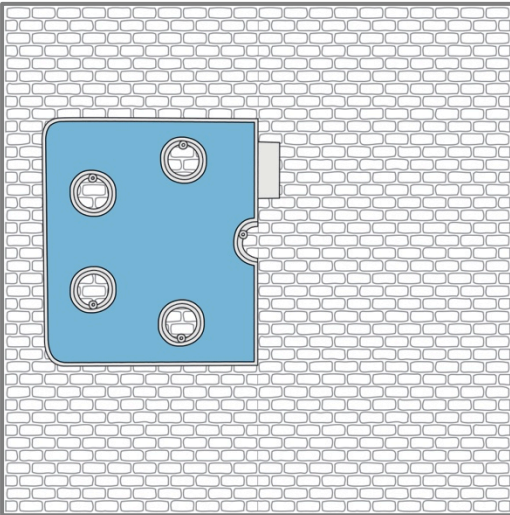

Tighten fixings by hand x 5.

09

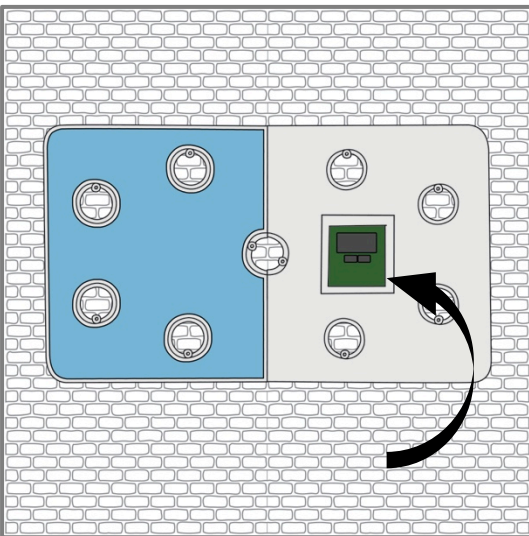

**2 people required:** Position the right- side moulding next to the left-side moulding on the wall.

10

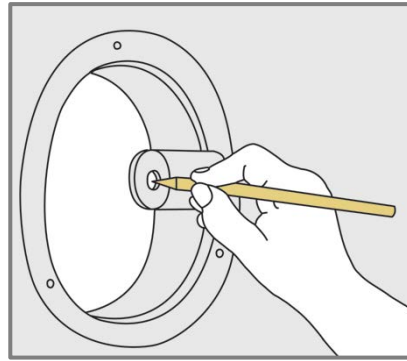
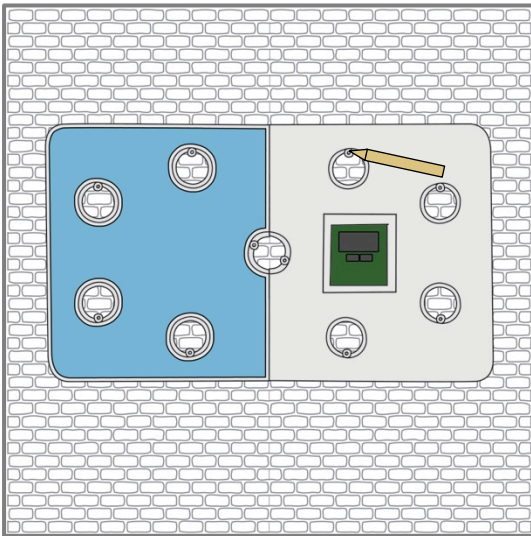

**2 people required:** one to hold the main body in place; one to clearly mark holes x 5.

11

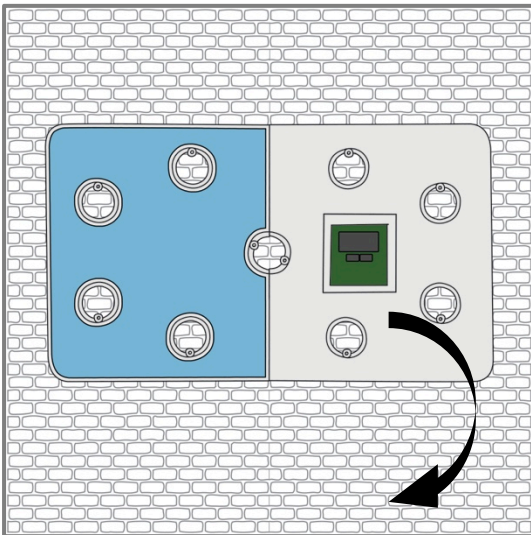

Remove the right-side moulding from the wall.

12

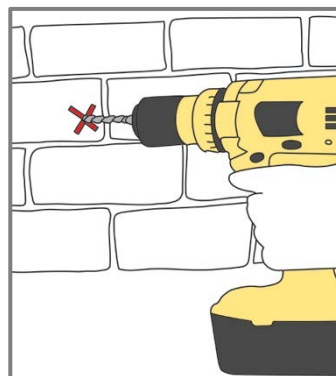
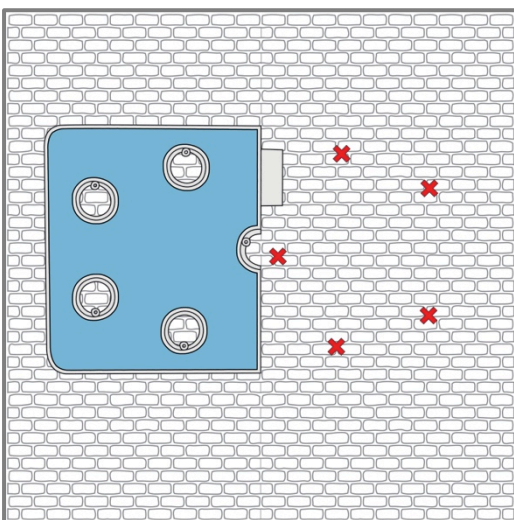

Drill holes and insert mountings x 5.

13

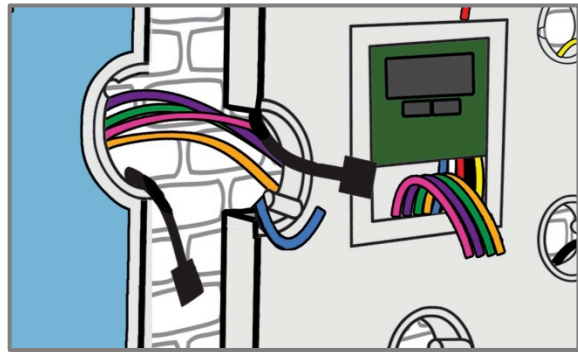
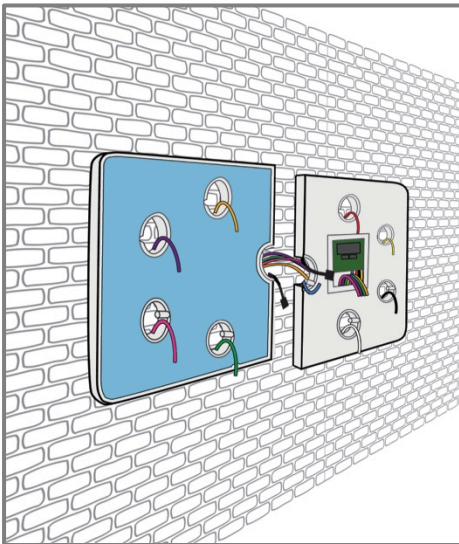

**2 people required:** one to hold the CardioWall in place; one to feed the cables from the left-side of the left section through the slot at the back of the right section.

14

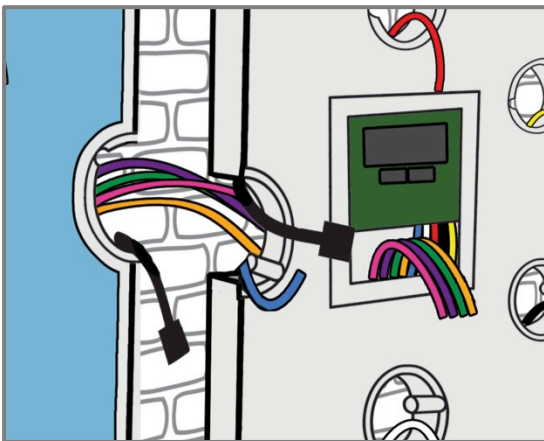

When the right-side section is put against the wall, ensure all cables from the left-side moulding follow the channel behind the right-side moulding and ensure that they are not trapped or pinched between the wall sections.

15

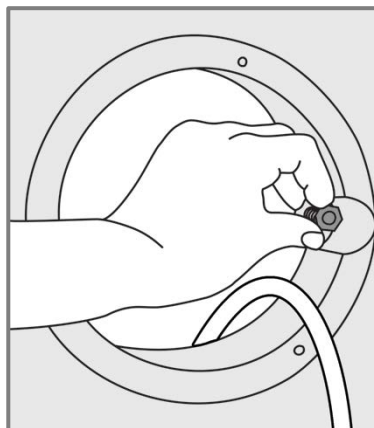
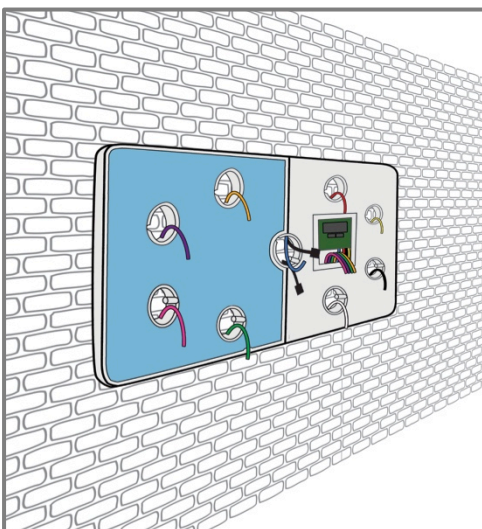

Tighten fixings by hand x 5.



16

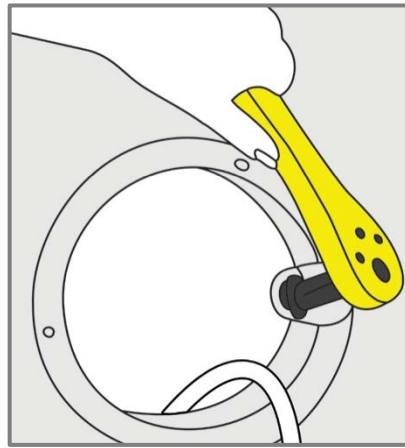
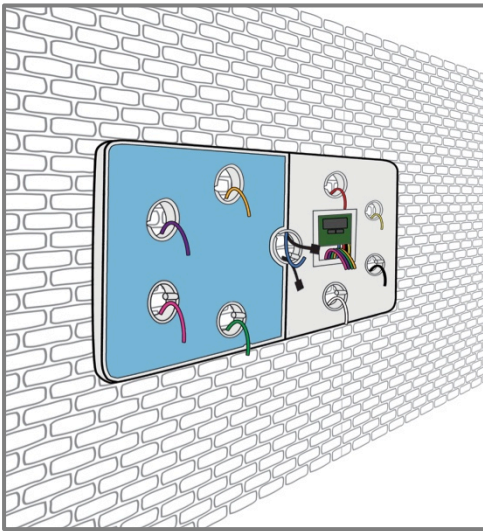

Tighten fixings with tool x 10.

17

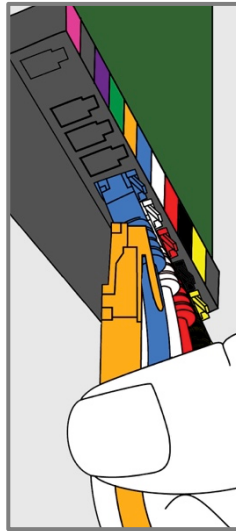
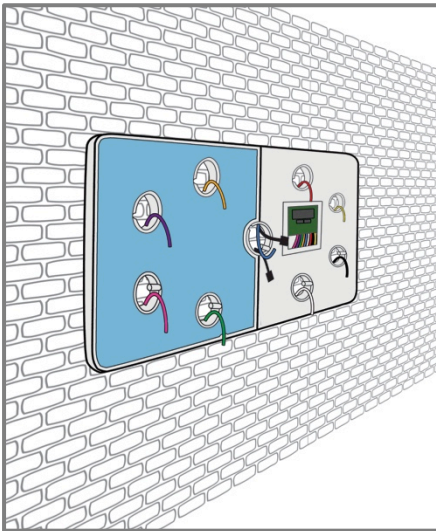

Connect the lower CAT5 cables x 4 in the designated slots on the hub PCB.

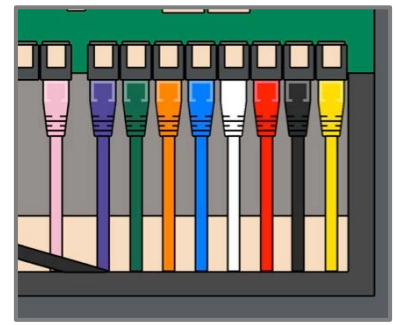

18

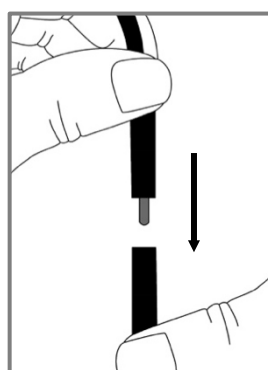
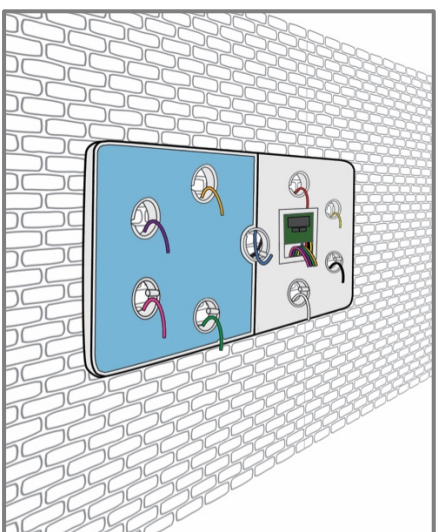

Connect the power cable in the centre pod opening.

19

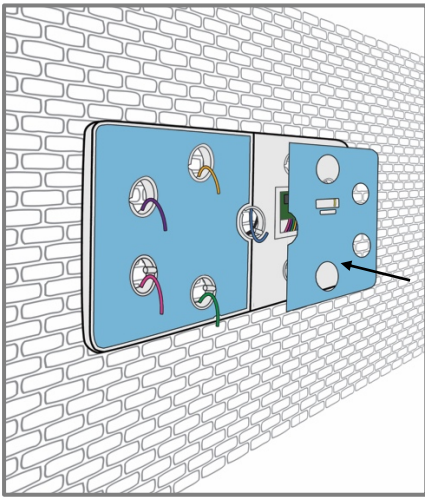

Reposition the graphics panels for the top moulding. Use the screws and washers retained from earlier.

20

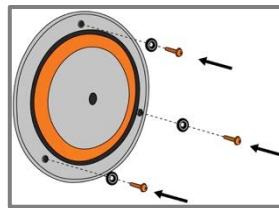
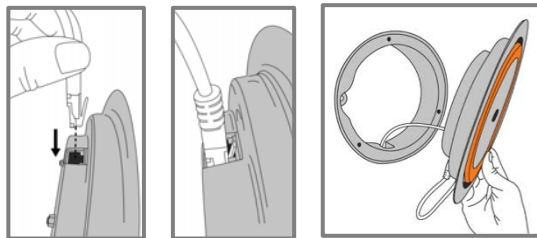
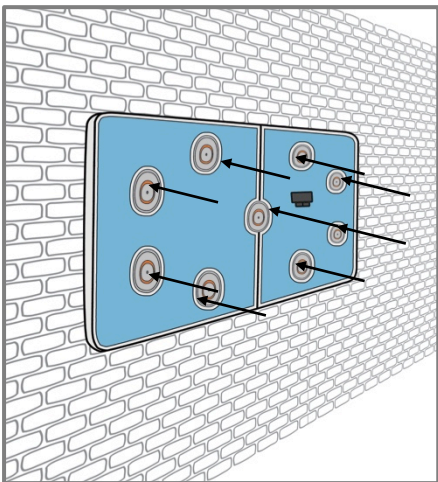

Reinstall pods x 9. Ensure cable is not trapped when replacing pod.

21

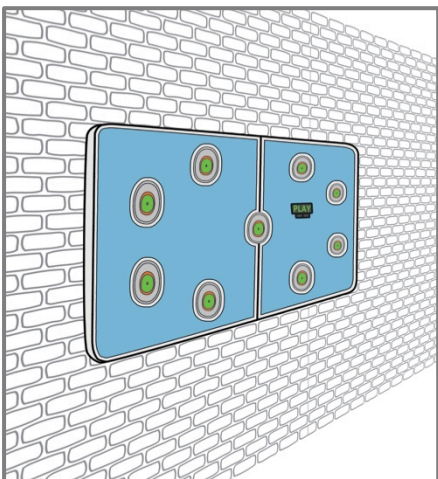



rugged. interactive

**Rugged Interactive**

Unit 1, Callywith Court,  
Callywith Gate Industrial Estate,  
Bodmin, Cornwall, UK  
PL31 2RQ

# CardioWall – Pod Removal and Installation

## Removing the Pods

Read this manual before removing or installing any pods.

Do not worry which order the pods come off in. They can be refitted in any order.

**Retain all screws & washers.**

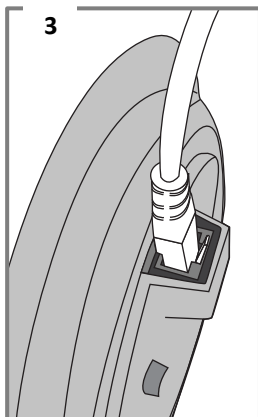
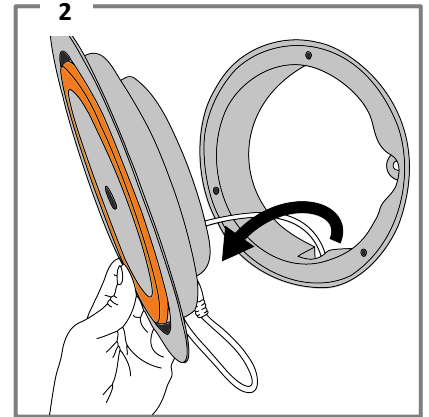
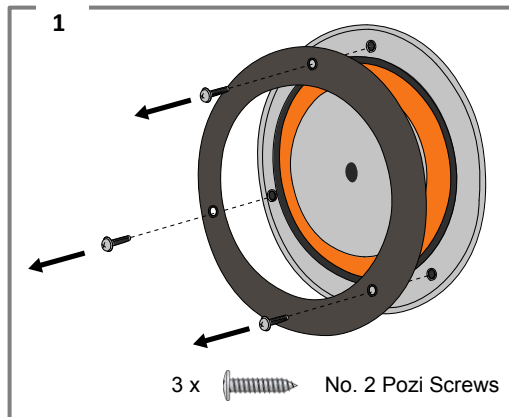

### NOTE:

To remove the CAT5 cables, push the clip to release.

Remove the CAT5 cables **CAREFULLY**.

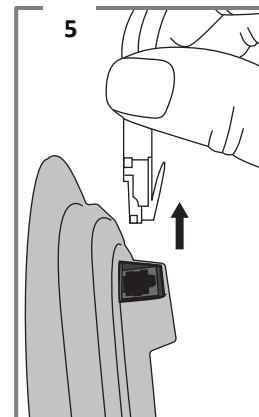
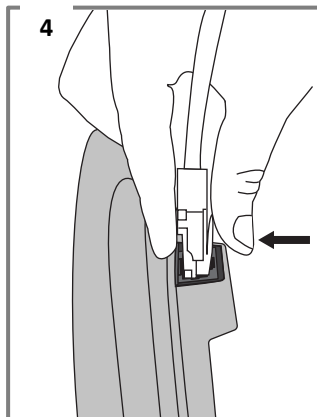

## Installing the Pods

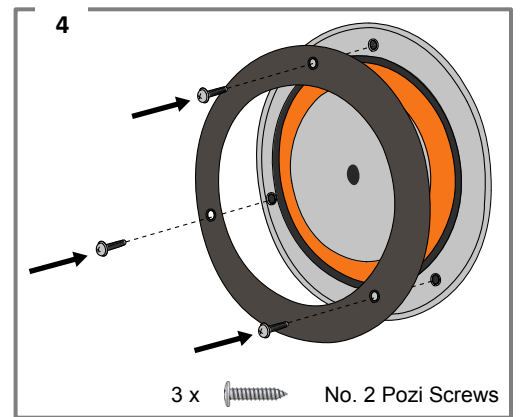
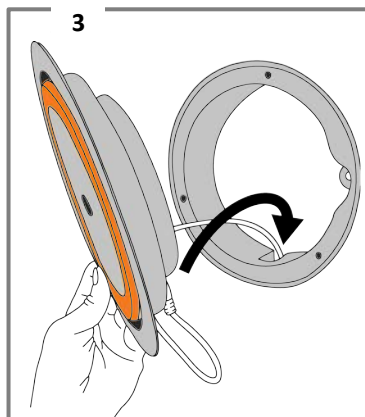
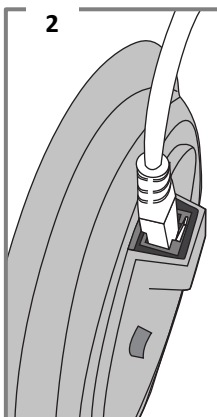
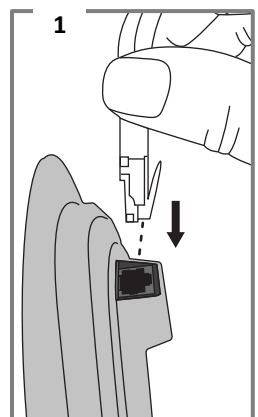

Ensure the clip is firmly connected. A click should be heard when inserted correctly.

The securing ring **MUST** be fitted to the new pods.



**Rugged Interactive**  
Unit 1, Callywith Court  
Callywith Industrial Estate, Bodmin  
Cornwall, UK  
PL31 2RQ

+44 (0) 1726 981 123  
www.rugged-interactive.com  
hello@rugged-interactive.com

## Section 4 - How to Use

---

### 4.1 Standard CardioWall

4.1.1 Idle State	Section 4 - 2
4.1.2 Menu	Section 4 - 3
4.1.3 5 Pod Menu	Section 4 - 5
4.1.4 End of Program	Section 4 - 6

### 4.2 Ability CardioWall

4.2.1 Idle State	Section 4 - 7
4.2.2 Menu	Section 4 - 8
4.2.3 5 Pod Menu	Section 4 - 10
4.3.4 SoundBoard	Section 4 - 11
4.2.5 End of Program	Section 4 - 12

## 4.1 Standard CardioWall

### 4.1.1 Idle State

On power up, the CardioWall will sound a 'laugh' and will turn to its idle state. Initially the dot matrix will display the **Hub Software Version Number** for the CardioWall.

The Standard CardioWall has **two menu options**:

1. **Menu** – Choose the playing time, level and range of playable pods for specific programs.
2. **5 Pod Menu** – Provides QuickStarts to play the middle 5 pods only for specific programs; designed for users with restricted movement such as wheelchair users.

The Standard CardioWall has **four programs**:

1. **ClearOut**
2. **ClusterShot**
3. **Chaser**
4. **CardioBeat**

In this idle state, the **green pods** are QuickStart options for the programs. The **blue pods** are menu options [Figure 4.1].

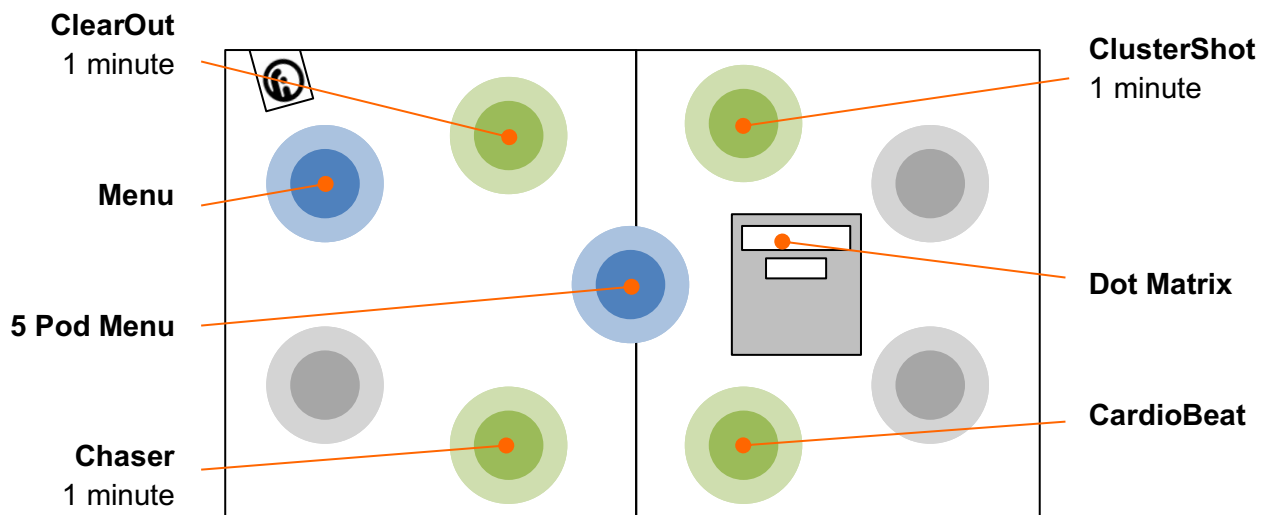

Figure 4.1: CardioWall Idle State



#### 4.1.2 Menu

Select the **Menu** option to choose the playing duration and the range of playable pods for **ClearOut**, **Chaser** and **ClusterShot**. For **ClusterShot**, the difficulty level can also be set.

On selection of the **Menu** option, the CardioWall will sound “Select programme.” This will then be followed by “ClearOut,” “ClusterShot,” then “Chaser,” which will sound in synchronisation with the respective pods flashing up. This routine will be repeated until an option is selected or the CardioWall times out after 20 seconds.

Select the **blue pod** to return the CardioWall to its idle state. Select either the **yellow**, **green** or **red** pods to set the playing options for **ClearOut**, **ClusterShot** or **Chaser** respectively [Figure 4.2].

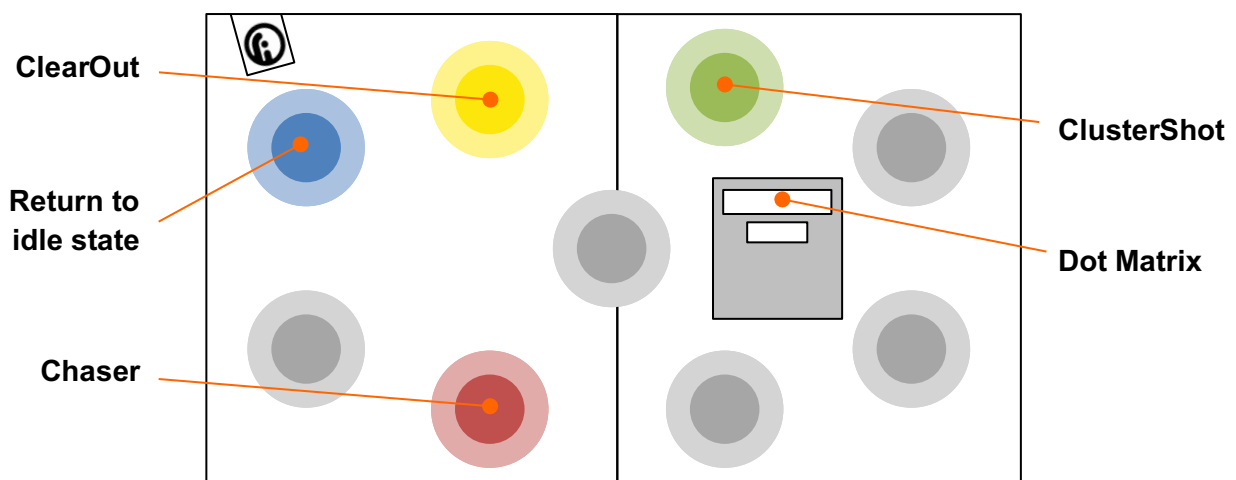
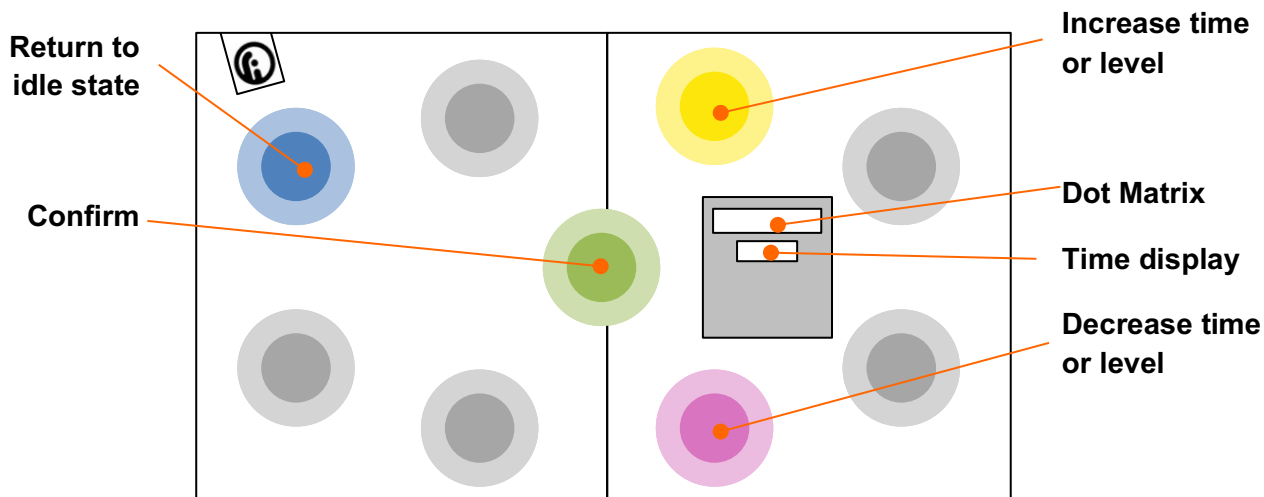

Figure 4.2: CardioWall Menu

Once the chosen game has been selected, the CardioWall will sound “Select time.” Select the **yellow pod** to increase the duration of the program. Select the **pink pod** to decrease the duration of the program. Select the **green pod** to confirm the chosen duration. Select the **blue pod** to return the CardioWall to its idle state. The program duration will be shown on the time display **[Figure 4.3]**.



**Figure 4.3:** CardioWall Time Select

In the **ClusterShot** options menu, once the chosen program duration has been confirmed, the CardioWall will sound “Select level.” The lights will be illuminated in the same way as **Figure 4.3**.

Select the **yellow pod** to increase the difficulty level. Select the **pink pod** to decrease the difficulty level. Select the **green pod** to confirm the chosen difficulty level. Select the **blue pod** to return the CardioWall to its idle state. The difficulty level will be shown on the time display.

Once the chosen time has been confirmed for **ClearOut/Chaser**, or the difficulty level has been confirmed for **ClusterShot**, the program will begin.

**NOTE:** For **ClearOut** and **Chaser** programs, the select difficulty level option is unavailable as there is only one level setting available.

**NOTE:** At any time, if the CardioWall behaves unexpectedly, wait for at least 20 seconds for the unit to reset to its idle state.

### 4.1.3 5 Pod Menu

The 5 Pod Menu is specifically designed for users with restricted movements such as wheelchair users. Selecting the 5 Pod Menu will display QuickStart options for the programs **ClearOut**, **ClusterShot**, **Chaser** and **CardioBeat**. The 5 Pod Menu programs will only play the central 5 pods.

On selection of the 5 Pod Menu option, the CardioWall will sound “Select programme.” The lights will illuminate as shown in **Figure 4.4**.

Select any of the **green pods** to begin any of the 5 Pod Menu programs. Select the **blue pod** to return the CardioWall to its idle state.

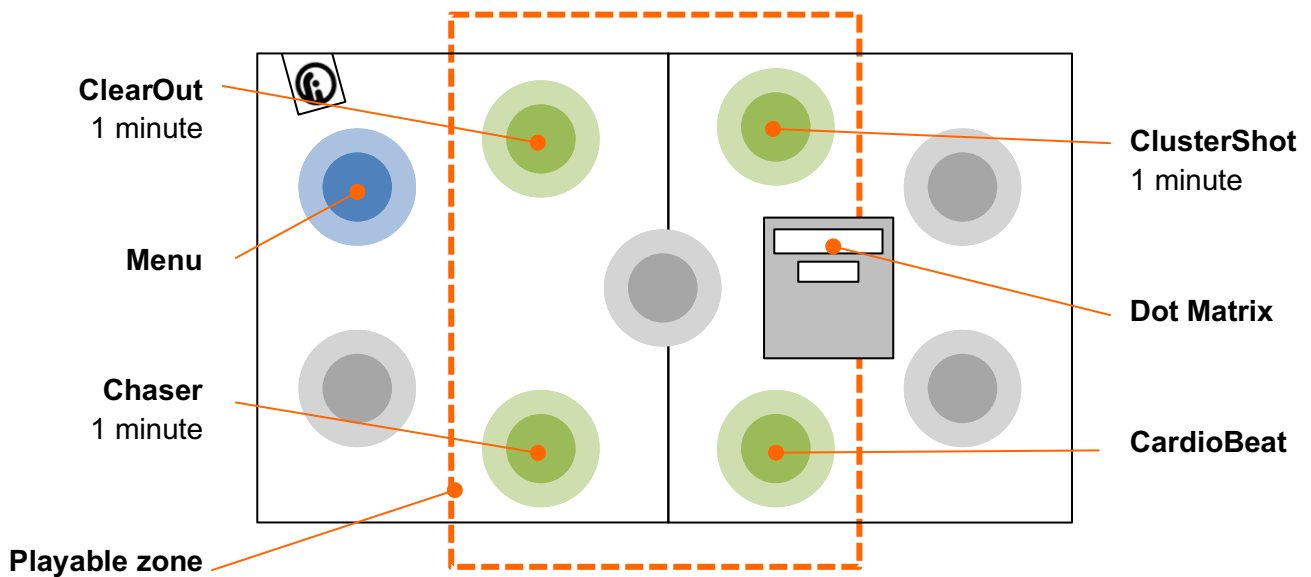

**Figure 4.4:** CardioWall 5 Pod Menu

**NOTE:** The **blue** Menu pod will remain active throughout these programs so it is possible to quit the program to the CardioWall’s idle state.

**NOTE:** At any time, if the CardioWall behaves unexpectedly, wait for at least 20 seconds for the unit to reset to its idle state.

#### 4.1.4 End of Program

At the end of any program, the CardioWall will sound, “Would you like to play again?” The pods will light up as shown in **Figure 4.5**. Selecting the **green pod** will replay the game. Selecting any of the **red pods** will return the CardioWall to its idle state.

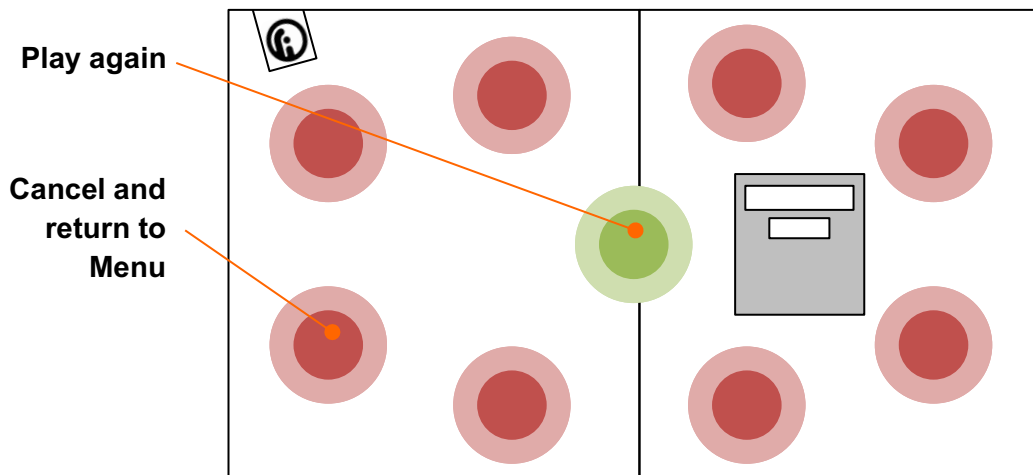

**Figure 4.5:** “Would you like to play again?”

**NOTE:** At any time, if the CardioWall behaves unexpectedly, wait for at least 20 seconds for the unit to reset to its idle state.

## 4.2 Ability CardioWall

### 4.2.1 Idle State

On power up, the CardioWall will sound a 'laugh' and will turn to its idle state. Initially the dot matrix will display the **Hub Software Version Number** for the CardioWall.

The Ability CardioWall has **two menu options**:

1. **Menu** – Choose the playing time, level and range of playable pods for specific programs.
2. **5 Pod Menu** – Provides QuickStarts to play the middle 5 pods only for specific programs; designed for users with restricted movement such as wheelchair users.

The Ability CardioWall has **four programs**:

1. **ClearOut**
2. **ClusterShot**
3. **Chaser**
4. **SoundBoard**

In this idle state, the **green pods** are QuickStart options for the programs. The **blue pods** are menu options [Figure 4.6].

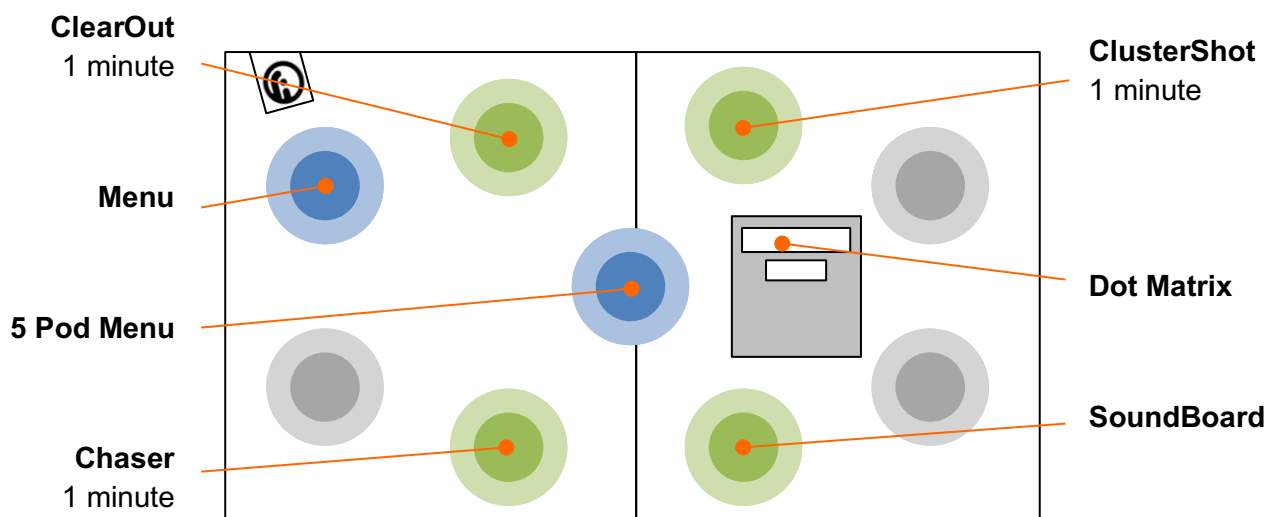

Figure 4.6: CardioWall Idle State

#### 4.2.2 Menu

Select the **Menu** option to choose the playing duration and the range of playable pods for **ClearOut**, **Chaser** and **ClusterShot**. For **ClusterShot**, the difficulty level can also be set.

On selection of the **Menu** option, the CardioWall will sound “Select programme.” This will then be followed by “ClearOut,” “ClusterShot,” then “Chaser,” which will sound in synchronisation with the respective pods flashing up. This routine will be repeated until an option is selected or the CardioWall times out after 20 seconds.

Select the **blue pod** to return the CardioWall to its idle state. Select either the **yellow**, **green** or **red** pods to set the playing options for **ClearOut**, **ClusterShot** or **Chaser** respectively [Figure 4.7].

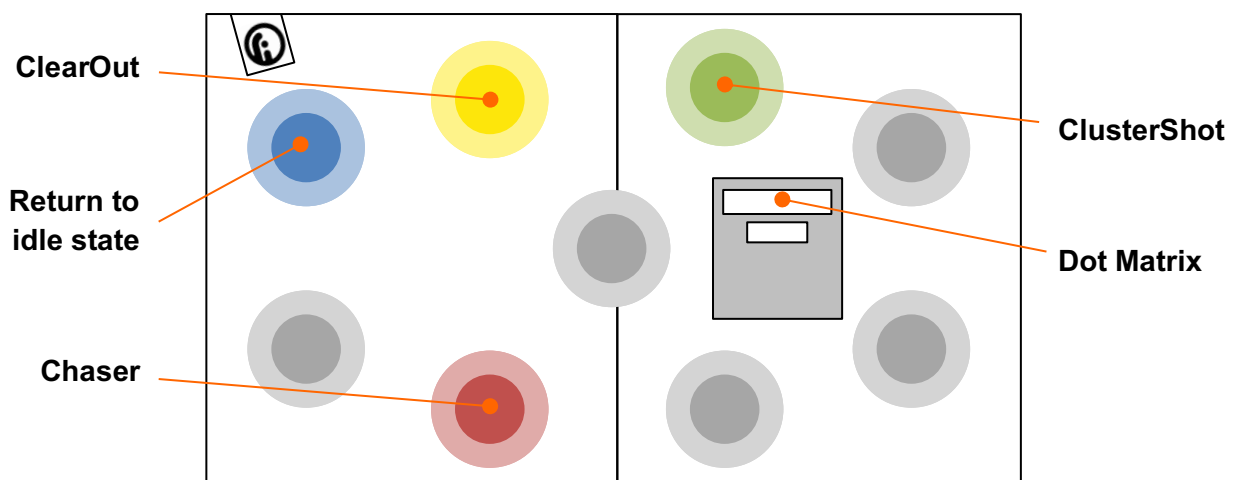
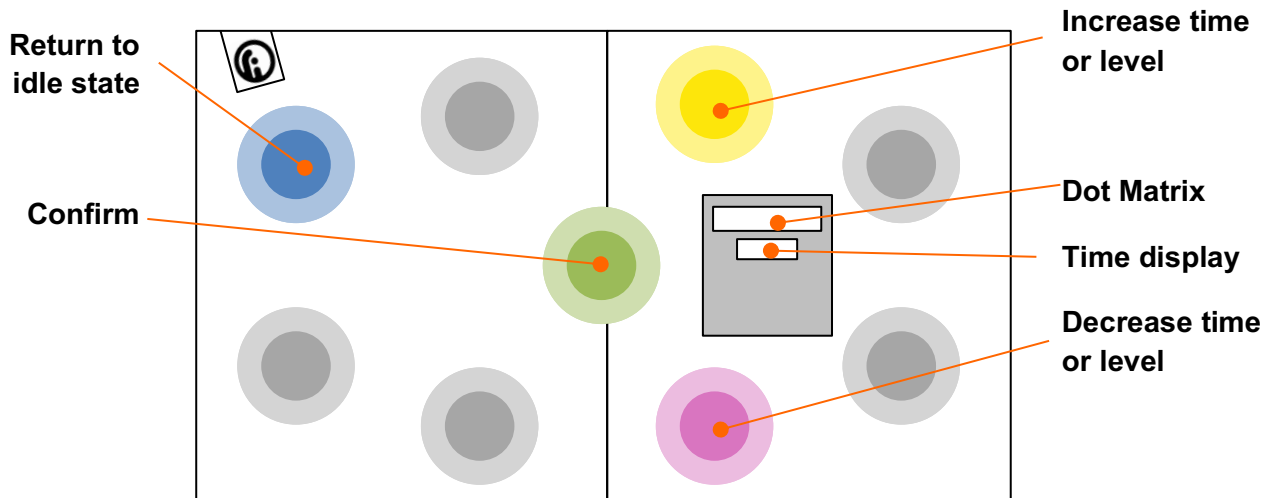

Figure 4.7: CardioWall Menu

Once the chosen game has been selected, the CardioWall will sound “Select time.” Select the **yellow pod** to increase the duration of the program. Select the **pink pod** to decrease the duration of the program. Select the **green pod** to confirm the chosen duration. Select the **blue pod** to return the CardioWall to its idle state. The program duration will be shown on the time display **[Figure 4.8]**.



**Figure 4.8:** CardioWall Time Select

In the **ClusterShot** options menu, once the chosen program duration has been confirmed, the CardioWall will sound “Select level.” The lights will be illuminated in the same way as **Figure 4.8**.

Select the **yellow pod** to increase the difficulty level. Select the **pink pod** to decrease the difficulty level. Select the **green pod** to confirm the chosen difficulty level. Select the **blue pod** to return the CardioWall to its idle state. The difficulty level will be shown on the time display.

Once the chosen time has been confirmed for **ClearOut/Chaser**, or the difficulty level has been confirmed for **ClusterShot**, the program will begin.

**NOTE:** For **ClearOut** and **Chaser** programs, the select difficulty level option is unavailable as there is only one level setting available.

**NOTE:** At any time, if the CardioWall behaves unexpectedly, wait for at least 30 seconds for the unit to reset to its idle state.

### 4.2.3 5 Pod Menu

The 5 Pod Menu is specifically designed for users with restricted movements such as wheelchair users. Selecting the 5 Pod Menu will display QuickStart options for the programs **ClearOut**, **ClusterShot** and **Chaser**. The 5 Pod Menu programs will only play the central 5 pods.

On selection of the 5 Pod Menu option, the CardioWall will sound, “Select programme.” The lights will illuminate as shown in **Figure 4.9**.

Select any of the **green pods** to begin any of the 5 Pod Menu programs. Select the **blue pod** to return the CardioWall to its idle state.

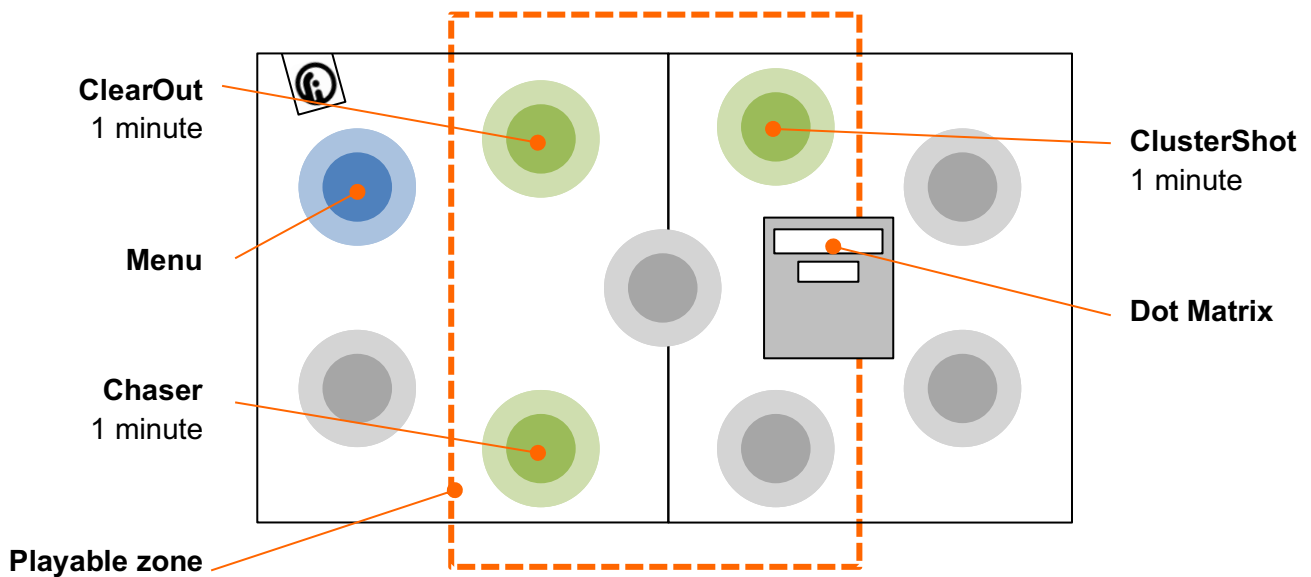

**Figure 4.9:** CardioWall 5 Pod Menu

**NOTE:** The **blue** Menu pod will remain active throughout these programs so it is possible to quit the program to the CardioWall's idle state.

**NOTE:** At any time, if the CardioWall behaves unexpectedly, wait for at least 30 seconds for the unit to reset to its idle state.



#### 4.2.4 SoundBoard

**SoundBoard** is an interactive, multi-sound, non-competitive sound synthesiser. It is popular with users whom have sensory processing disorders such as autism, brain injury and dementia.

On selection of **SoundBoard**, 8 pods will light up in various colours [Figure 4.10]. Each lit pod is a sound set. Select a sound set to experience 5 different sounds with in that set.

Select the top-left pod to return to the **Menu**.

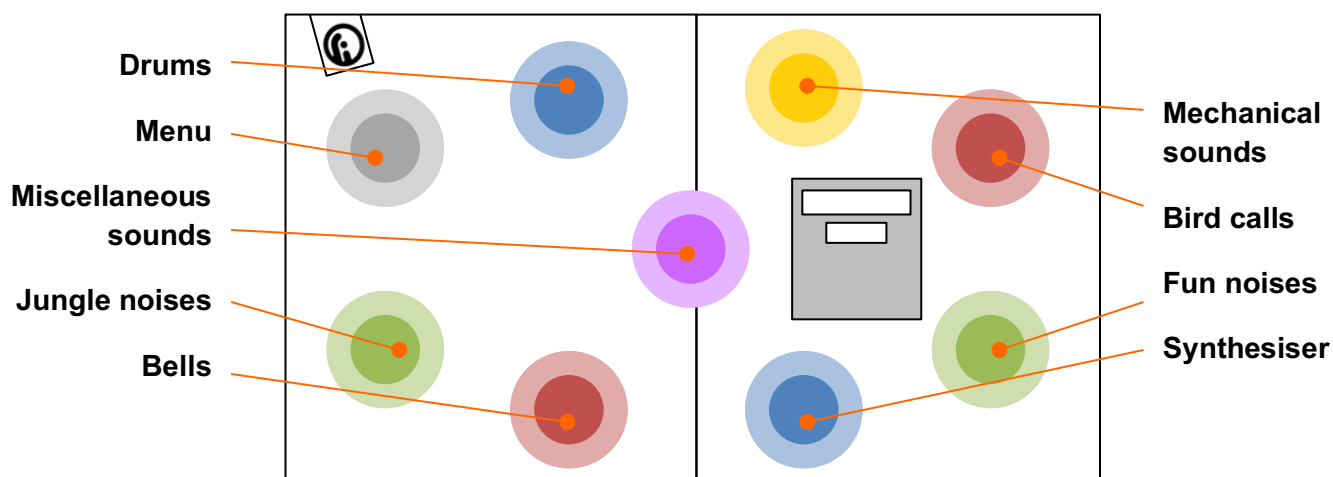
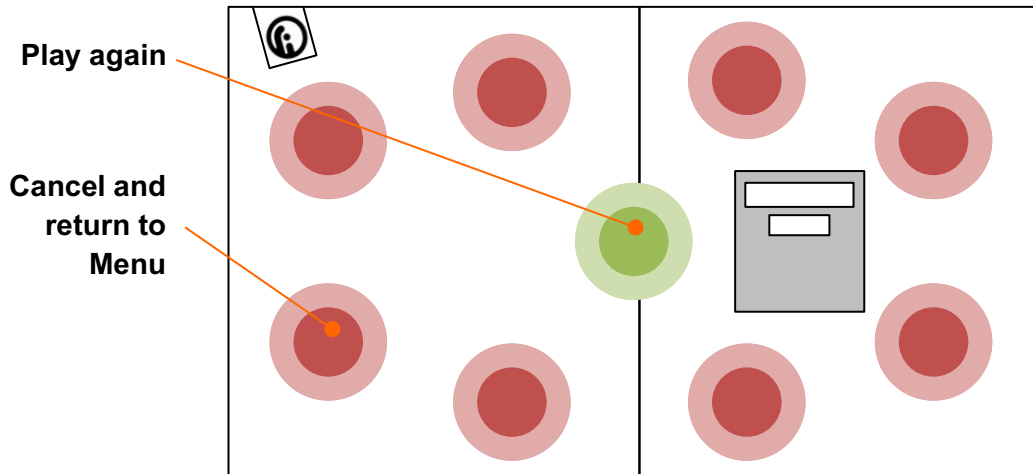

Figure 4.10: CardioWall SoundBoard

**NOTE:** At any time, if the CardioWall behaves unexpectedly, wait for at least 30 seconds for the unit to reset to its idle state.

#### 4.2.5 End of Program

At the end of any program, the CardioWall will sound, “Would you like to play again?” The pods will light up as shown in **Figure 4.11**. Selecting the **green pod** will replay the game. Selecting any of the **red pods** will return the CardioWall to its idle state.



**Figure 4.11:** “Would you like to play again?”

**NOTE:** At any time, if the CardioWall behaves unexpectedly, wait for at least 30 seconds for the unit to reset to its idle state.



## Rugged Interactive

Unit 1, Callywith Gate  
Callywith Industrial Estate, Bodmin  
Cornwall, UK  
PL31 2RQ

+44 (0) 1726 981 123

[www.rugged-interactive.com](http://www.rugged-interactive.com)

[hello@rugged-interactive.com](mailto:hello@rugged-interactive.com)

# Section 5 - Programs Guide

---

## 5.1 ClearOut

**Summary:** For repetitive exercise, stamina building and core stability. Popular within circuit training routines and effective with all types of accessory.

**CardioWall:** Standard and Ability.

**Gameplay:** All pods will appear **green**. On selection of each illuminated pod, the light will turn out. Once all lit pods are cleared, all pods will reappear **blue**. Once all of the **blue pods** are cleared, all pods will reappear **red**. Once all of the **red pods** are cleared, all pods will reappear **green**, etc.

**Aim:** To clear as many illuminated pods as possible within the given time limit.

**Scoring system:** +1 point for each pod hit

**Duration:** 0.5 / 1 / 2 / 3 / 4 / 5 / 10 / 15 / 20 / 25 / 30 minutes

**NOTE:** At any time, if the CardioWall behaves unexpectedly during gameplay, wait for at least 30 seconds for the unit to reset to its idle state. For gameplay greater than or equal to 10 minutes, wait for at least 2 minutes for the unit to reset to its idle state. This longer time-out period is designed to allow multiplayer circuit training.

## 5.2 ClusterShot

<b>Summary:</b>	A high intensity challenge of speed and visual awareness. Mentally testing.
<b>CardioWall:</b>	Standard and Ability.
<b>Gameplay:</b>	Pods will illuminate in clusters of 3, 4 or 5 at random. The illuminated pods will firstly appear <b>green</b> , then <b>yellow</b> , then <b>red</b> . Once an entire cluster of lit pods are cleared, a new cluster of lit pods will appear at random.
<b>Aim:</b>	To earn as many points as possible within the given time limit by hitting the illuminated pods quickly.
<b>Difficulty:</b>	Beginner (Slow) – Level 1 Intermediate (Medium) – Level 2 Expert (Fast) – Level 3
<b>Scoring system:</b>	+3 point for each <b>green pod</b> hit +2 point for each <b>yellow pod</b> hit +1 point for each <b>red pod</b> hit
<b>Duration:</b>	0.5 / 1 / 2 / 3 / 4 / 5 / 10 / 15 / 20 / 25 / 30 minutes

**NOTE:** At any time, if the CardioWall behaves unexpectedly during gameplay, wait for at least 30 seconds for the unit to reset to its idle state. For gameplay greater than or equal to 10 minutes, wait for at least 2 minutes for the unit to reset to its idle state. This longer time-out period is designed to allow multiplayer circuit training.

### 5.3 Chaser

<b>Summary:</b>	A pure speed and reaction challenge which also tests peripheral vision.
<b>CardioWall:</b>	Standard and Ability.
<b>Gameplay:</b>	A single <b>red pod</b> will illuminate at random. Other pods will be <b>green</b> . On selection of the <b>red pod</b> (the chaser), another pod will reappear <b>red</b> .
<b>Aim:</b>	To hit as many <b>red pods</b> with in the given time limit as possible.
<b>Scoring system:</b>	+1 point for each <b>red pod</b> hit -1 point for each <b>green pod</b> hit
<b>Duration:</b>	0.5 / 1 / 2 / 3 / 4 / 5 / 10 / 15 / 20 / 25 / 30 minutes

**NOTE:** At any time, if the CardioWall behaves unexpectedly during gameplay, wait for at least 30 seconds for the unit to reset to its idle state. For gameplay greater than or equal to 10 minutes, wait for at least 2 minutes for the unit to reset to its idle state. This longer time-out period is designed to allow multiplayer circuit training.

## 5.4 CardioBeat

- Summary:** A version of the 'bleep test.' A perfect measure of a user's fitness, including hand speed, accuracy and stamina. The first port of call for personal trainers with a new client. Helps to develop hand-eye coordination.
- CardioWall:** Standard.
- Gameplay:** All pods will illuminate. Once each illuminated pod is hit, the light will turn out. All pods must be cleared within the given time to clear the level. If the level is cleared in time, a beep will sound and all pods will reappear. This is repeated until the user is unable to clear the entire wall of illuminated pods. The time that the lights are illuminated for decreases as the level increases, steadily increasing the games difficulty.
- Aim:** To clear the entire wall of illuminated pods as many times as possible with in time restrictions.
- Difficulty:** Increases as the level increases.
- Scoring system:** Level increases by 1.0 for each cleared level  
Level increases by 0.1 point for each pod hit  
e.g. L7.2

**NOTE:** At any time, if the CardioWall behaves unexpectedly, wait for the program to end and for the unit to reset to its idle state.

## 5.5 SoundBoard

**Summary:** An interactive, multi-sound, non-competitive sound synthesiser. Popular with users whom have sensory processing disorders such as autism, brain injury and dementia.

**CardioWall:** Ability.

**Gameplay:** 8 pods will light up in various colours. Each lit pod is a sound set. Select a sound set to experience 5 different sounds with in that set.

**Sounds key** - top left to bottom right:

**Green** – jungle noises

**Blue** – drums

**Red** – bells

**Pink** – miscellaneous sounds

**Yellow** – mechanical sounds

**Blue** – synthesiser

**Red** – bird calls

**Green** – fun noises

**Aim:** Play and enjoy the sounds.

**Scoring system:** N/A

**Duration:** 3 minutes

**NOTE:** At any time, if the CardioWall behaves unexpectedly during gameplay, wait for at least 30 seconds for the unit to reset to its idle state.



## Rugged Interactive

Unit 1, Callywith Court,  
Callywith Industrial Estate,  
Bodmin, Cornwall, UK  
PL31 2RQ

+44 (0) 1726 981 123

[www.rugged-interactive.com](http://www.rugged-interactive.com)

[hello@rugged-interactive.com](mailto:hello@rugged-interactive.com)

# CardioWall Landscape System Specifications

---

## Dimensions and Weights:

	Approx. Shipment Details		Fully Assembled Details	
	Size (mm)	Weight	Size (mm)	Weight
<b>CardioWall Landscape</b> ( <i>single unit</i> )	1150 x 1250 x 300	70 kg	2125 x 55 x 1220	42 kg
<b>Mobile Stand</b> ( <i>without CardioWall</i> )	1450 x 1000 x 1500	105 kg	1450 x 1000 x 1500	80 kg

## Power Supply:

AC: 110-230V, 50-60Hz, 13A

## Warranty:

1 year on electronics. 3 years on all other parts.

## Regulatory Requirements:

CE Approved.

## Operating Environment:

Indoors: keep dry and out of direct sunlight.

Mount to a wall of a suitable construction.

Area required clear in front of the CardioWall: depth of 1 m minimum.

Optimum ambient temperature: 5°C to 30°C. Avoid extreme fluctuations of temperature.

## Other:

All parts designed for easy maintenance. Replacement LED pods can be swapped out by staff in seconds.



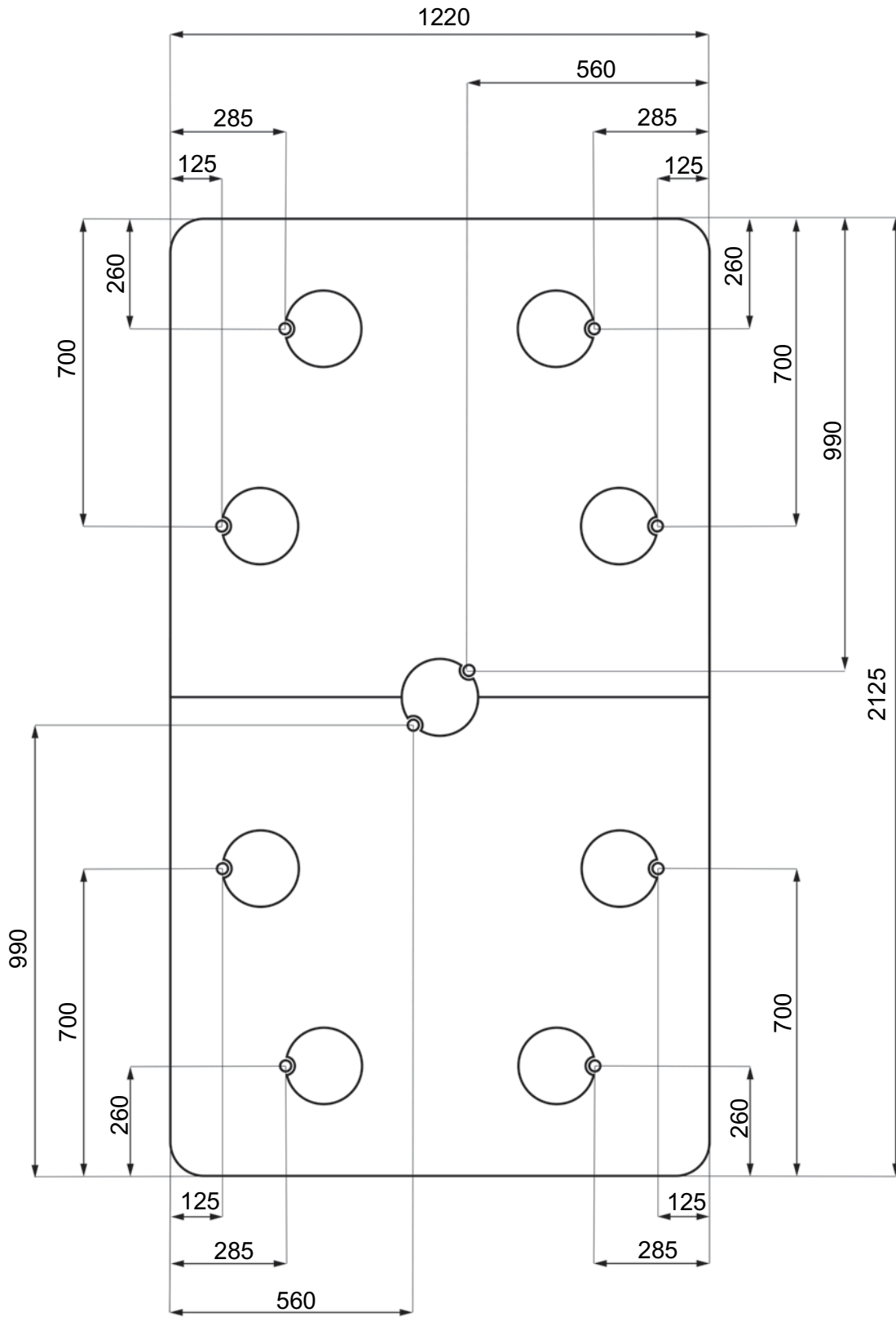

Figure 1: CardioWall Landscape mounting points  
(Dimensions in mm)



## ■ Features

- Universal AC input / Full range
- 2 pole AC inlet IEC320-C8
- Medical safety approved (2 x MOPP between primary to secondary)
- Suitable for BF application with appropriate system consideration
- Low leakage current <50uA
- No load power consumption<0.1W
- Energy efficiency level VI(Except 5~9V for Level V)
- Comply with EISA 2007/DoE,NRCan, AU/NZ MEPS, EU ErP and meet CoC Version 5
- Built-in active PFC function
- High efficiency up to 91.5%
- Fanless design with -30~+60°C working temperature
- Class II power (without earth pin)
- Protections: Short circuit / Overload / Over voltage / Over temperature
- Fully enclosed plastic case
- LED indicator for power on
- 100% full load burn-in test



## Power Supply Specification

### SPECIFICATION

<b>PRODUCT</b>		<b>GSM60B12-P1J</b>	
<b>OUTPUT</b>	<b>SAFETY MODEL NO.</b>	GSM60B12	
	<b>DC VOLTAGE</b> <small>Note.2</small>	12V	
	<b>RATED CURRENT</b>	5A	
	<b>CURRENT RANGE</b>	0 ~ 5A	
	<b>RATED POWER (max.)</b>	60W	
	<b>RIPPLE &amp; NOISE (max.)</b> <small>Note.3</small>	100mVp-p	
	<b>VOLTAGE TOLERANCE</b> <small>Note.4</small>	± 3.0%	
	<b>LINE REGULATION</b> <small>Note.5</small>	± 1.0%	
	<b>LOAD REGULATION</b>	± 3.0%	
	<b>SETUP, RISE TIME</b> <small>Note.6</small>	1000ms, 30ms / 230VAC      1500ms, 30ms / 115VAC at full load	
<b>HOLD UP TIME (Typ.)</b>	50ms / 230VAC      15ms / 115VAC at full load		
<b>INPUT</b>	<b>VOLTAGE RANGE</b> <small>Note.7</small>	80 ~ 264VAC    120 ~ 370VDC	
	<b>FREQUENCY RANGE</b>	47 ~ 63Hz	
	<b>EFFICIENCY (Typ.)</b>	88%	
	<b>AC CURRENT (Typ.)</b>	1.4A / 115VAC    1A / 230VAC	
	<b>INRUSH CURRENT (Typ.)</b>	30A / 115VAC    65A / 230VAC	
	<b>LEAKAGE CURRENT(max.)</b>	Touch current < 50µA/264VAC	
<b>PROTECTION</b>	<b>OVERLOAD</b>	105 ~ 160% rated output power Protection type : Hiccup mode, recovers automatically after fault condition is removed	
	<b>OVER VOLTAGE</b>	12.6 ~ 16.2V Protection type : Shut down o/p voltage, re-power on to recover	
	<b>OVER TEMPERATURE</b>	Shut down o/p voltage, re-power on to recover	
<b>ENVIRONMENT</b>	<b>WORKING TEMP.</b>	-30 ~ +60°C (Refer to "Derating Curve")	
	<b>WORKING HUMIDITY</b>	20% ~ 90% RH non-condensing	
	<b>STORAGE TEMP., HUMIDITY</b>	-40 ~ +85°C, 10 ~ 95% RH	
	<b>TEMP. COEFFICIENT</b>	± 0.03% / °C (0 ~ 40°C)	
	<b>VIBRATION</b>	10 ~ 500Hz, 2G 10min./1cycle, period for 60min. each along X, Y, Z axes	
<b>SAFETY &amp; EMC (Note. 8)</b>	<b>SAFETY STANDARDS</b>	ANSI/AAMI ES60601-1 / ES60601-1-11, TUV EN60601-1 / 60601-1-11 approved	
	<b>ISOLATION LEVEL</b>	Primary-Secondary: 2xMOPP	
	<b>WITHSTAND VOLTAGE</b>	I/P-O/P:4KVAC	
	<b>ISOLATION RESISTANCE</b>	I/P-O/P:100M Ohms / 500VDC / 25°C / 70% RH	
	<b>EMC EMISSION</b>	Compliance to EN55011(CISPR11) class B, EN61000-3-2,3, FCC PART 15 class B,CAN ICES-3(B)/NMB-3(B)	
	<b>EMC IMMUNITY</b>	Compliance to EN61000-4-2,3,4,5,6,8,11, EN55024, EN60601-1-2, EN61204-3 medical level, criteria A	
<b>OTHERS</b>	<b>MTBF</b>	720K hrs min. MIL-HDBK-217F(25°C)	
	<b>DIMENSION</b>	125*50*31.5mm (L*W*H)	
	<b>PACKING</b>	0.32Kg; 40pcs/13.8Kg/1.05CUFT	
<b>CONNECTOR</b>	<b>PLUG</b>	See page 3 ; Other type available by customer requested	
	<b>CABLE</b>	See page 3 ; Other type available by customer requested	
<b>NOTE</b>	<ol style="list-style-type: none"> <li>All parameters are specified at 230VAC input, rated load, 25°C 70% RH ambient.</li> <li>DC voltage: The output voltage set at point measure by plug terminal &amp; 50% load.</li> <li>Ripple &amp; noise are measured at 20MHz by using a 12" twisted pair terminated with a 0.1uf &amp; 47uf capacitor.</li> <li>Tolerance: includes set up tolerance, line regulation, load regulation.</li> <li>Line regulation is measured from low line to high line at rated load.</li> <li>Length of set up time is measured at first cold start. Turning ON/OFF the power supply may lead to increase of the set up time.</li> <li>Derating may be needed under low input voltages. Please check the derating curve for more details.</li> <li>The power supply is considered as an independent unit, but the final equipment still need to re-confirm that the whole system complies with the EMC directives. For guidance on how to perform these EMC tests, please refer to "EMI testing of component power supplies." (as available on <a href="http://www.meanwell.com">http://www.meanwell.com</a>)</li> </ol>		



■ Derating Curve

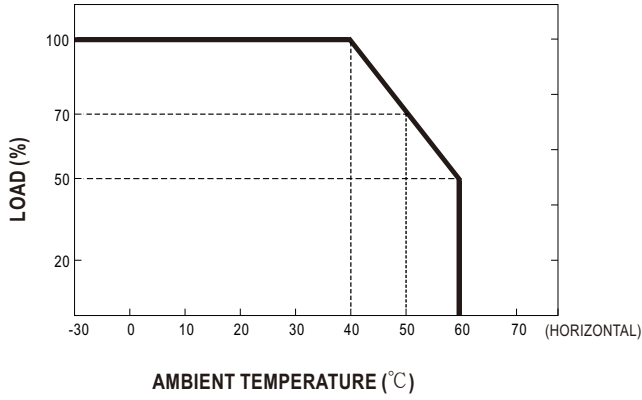

■ Static Characteristics

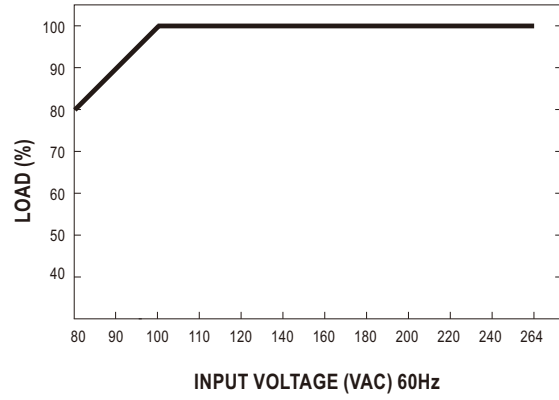

■ Mechanical Specification

Case No. GSM60B Unit:mm

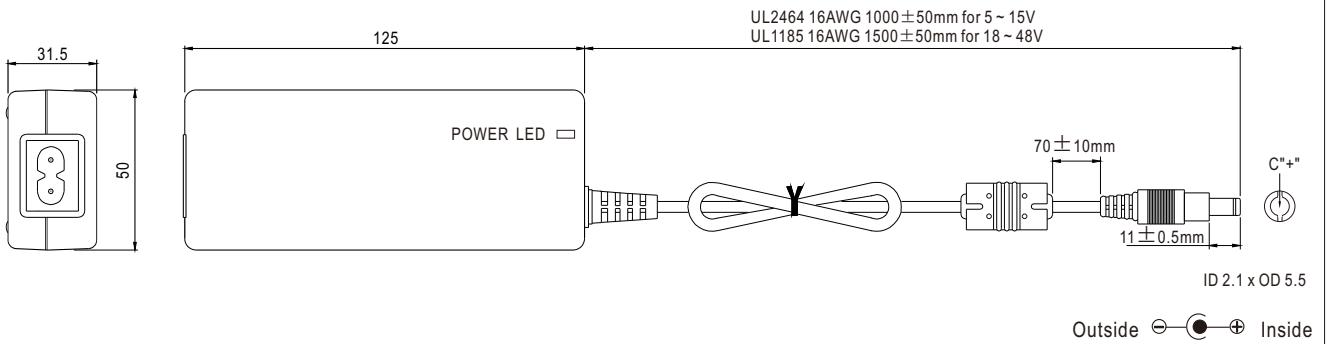

■ Plug Assignment

Standard plug: P1J

P1J	
P/N	OUTPUT
CENTER	+



**Rugged Interactive**

Unit 1, Callywith Court,  
Callywith Industrial Estate,  
Bodmin, Cornwall, UK  
PL31 2RQ

+44 (0) 1726 981 123

www.rugged-interactive.com

hello@rugged-interactive.com

# CardioWall Landscape Installation Checklist

---

Please complete this checklist after any installation:

## Check 1: Pre-power up checks.

Equipment is stable, secure and (if applicable) mounted to a wall of a suitable construction capable of supporting its weight and gameplay.

All fixings are tight and secure.

The power cables in the central pod are properly connected.

No signs of damage, component failure and/or missing parts.

No trapped and/or pinched cables.

No loose cables that could become a tripping hazard.

All long cables are supported at least every 50 cm.

Adequate strain relief provided for connection points.

Kept out of direct sunlight during the day.

All electric components away from contact with water.

Protective plastic sheets removed from front graphic panels and each pod.

## Check 2: Plug into a mains socket and power up.

All pods light up.

Text appears on the hub display and is as expected. *E.g. Landscape Standard.*

Sound volume is at a suitable level\*.

## Check 3: Select ClearOut (Speed) via Quick Start.

Program counts down from 3 and begins.

All pods active and operational.

Check all pods for colours: red, green, blue.

Sounds can be heard when the lights are hit.

Program plays as described in the Programs Guide.

**Check 4: Select Menu then select ClusterShot.**

- Time selection OK?
- Level selection OK?
- Program counts down from 3 and begins.
- All pods active and operational.
- Check all pods for colours: red, green, blue.
- Sounds can be heard when the lights are hit.
- Program plays as described in the Programs Guide.

**Check 5: Ready for use.**

- Play area is clear.
- Instruction / training carried out by an appropriate instructor to all new users.

**If anything unexpected occurs or problems persist after troubleshooting, call Rugged Interactive directly on +44 (0) 1726 833 882.**

\* If no external volume control is provided (usual for most CardioWalls), the volume can be adjusted on the main hub. The volume control (a small blue control) can be seen through the score window on the bottom left of the PCB. The volume can be adjusted by projecting a tiny flat-bladed screwdriver through the provided hole on the front of the graphics panel. Rotate clockwise for volume up, counter-clockwise for volume down.



## Rugged Interactive

Unit 1, Callywith Gate  
Callywith Industrial Estate, Bodmin  
Cornwall, UK  
PL31 2RQ

+44 (0) 1726 981 123

[www.rugged-interactive.com](http://www.rugged-interactive.com)

[hello@rugged-interactive.com](mailto:hello@rugged-interactive.com)

## Next Steps

---

### Train team members

Train your team members on how to use CardioWall Landscape, having knowledge of the gameplay will help them encourage users. Inspire them to cheer and celebrate with the users when they achieve high scores.

### Maintenance

General care and maintenance procedures for your Rugged Interactive product.

1. Inspect the product daily for any signs of damage or loose components. Repair or tighten as applicable.
2. Turn on the product, check the LEDs and sound is working as expected.
3. Start a game, check all pods/sensors work and react as expected. Please refer to the manual for instructions on gameplay.
4. If a pod has seven (7) or fewer working LEDs, we recommend replacing the pod.
5. We suggest non-solvent glass cleaning spray, avoid spraying directly onto the pods. Use a non-abrasive microfibre cloth and extremely light pressure when wiping the product. Too much pressure will scratch the graphics panel.
6. Only use accessories recommended by the manufacturer with the products. Accessories not recommended could cause serious damage.
7. Every three months check the fixings are tight.
8. Once a year, check the structure supporting the product is still solid.
9. We recommend turning the products off when they are not in use (close of business), this will help to extend the life of the product.

### Marketing

With this being such an eye-catching product, it is excellent for use in posts on social media, either featuring in photos or videos.

If you would like any help, guidance or examples of using this product in your marketing campaign, please contact Rugged Interactive and we will be able to assist with this.



## Rugged Interactive

Unit 1, Callywith Gate  
Callywith Industrial Estate, Bodmin  
Cornwall, UK  
PL31 2RQ

+44 (0) 1726 981 123

[www.rugged-interactive.com](http://www.rugged-interactive.com)

[hello@rugged-interactive.com](mailto:hello@rugged-interactive.com)

# Congratulations!

---

**Congratulations on your new Rugged Interactive product! Your customers are going to love this, and it is a great addition to your venue!**

If there is anything we can assist with or if you would be interested in information about any other Rugged Interactive products, then please do not hesitate to get in contact.